

MAXIMUM COMFORT AND CONTROL IN HEATING

**MODEL TSSHHC-3DP-2/3/4/7**

**SUMMARY**

**OPTIONS SELECTION**

Inside the thermostat there are 4 selection switches to set at your preferences.  
Cycles of 15 minutes or 20 seconds, temperature °C or °F; time in 12 or 24 hours and Early Start function.

**TO SET TIME AND DAY**

Press on DAY, HOUR and MIN buttons to adjust the time and day.

**TO RECORD THE ☀ (COMFORT) SETPOINT TEMPERATURE**

Select chosen setpoint temperature by using the ▲ or ▼ button. Press on ☀ button (2 to 3 seconds) until icon ☀ appears on display.

**TO RECORD THE ☾ (ECONOMY) SETPOINT TEMPERATURE**

Select chosen setpoint temperature by using the ▲ or ▼ button. Press on ☾ button (2 to 3 seconds) until ☾ icon appears on display

**TO RECORD THE 🗑 (VACATION) SETPOINT TEMPERATURE**

Select chosen setpoint temperature by using the ▲ or ▼ button. Press on ☀ and ☾ buttons simultaneously (2 to 3 seconds) until 🗑 icon appears on display.

**OPERATING MODES**

Use MODE button to select an operating mode or to exit the programming

**AUTO:** Runs the program. ▲ or ▼ shows temperature setting and can override temporarily your programming up to the next Program.

**MAN:** Maintains the selected temperature. ▲ or ▼ changes the temperature setting.

**INSTALLATION**

NOTE: The "Problems and Solutions" section located at the end of this Document will help you to correct the problems you might have during the installation.

This thermostat has been designed to operate with any installation which has a RESISTIVE load not exceeding 4000W (16.7 A) @ 240 VAC or 2000W @ 120VAC as electric baseboards, radiant ceilings and floors, electric convectors, etc. It is not compatible with a low voltage controller used by a central heating system or systems using a contactor or a relay whose current is under 1.0A.

Electricians or experienced technicians should install the thermostat. This thermostat is designed to be used with a self-protected heating system equipped with linear limit control and circuit breaker.

**PARTS INCLUDED:**

- One (1) TSSHHC-3DP-2/3/4/7 thermostat
- Two (2) 6-32 screws.
- Two (2) solderless connectors

TURN OFF POWER OF THE HEATING SYSTEM AT MAIN POWER PANEL TO AVOID ELECTRIC SHOCK. Keep air vents of thermostat clean and free from obstructions.

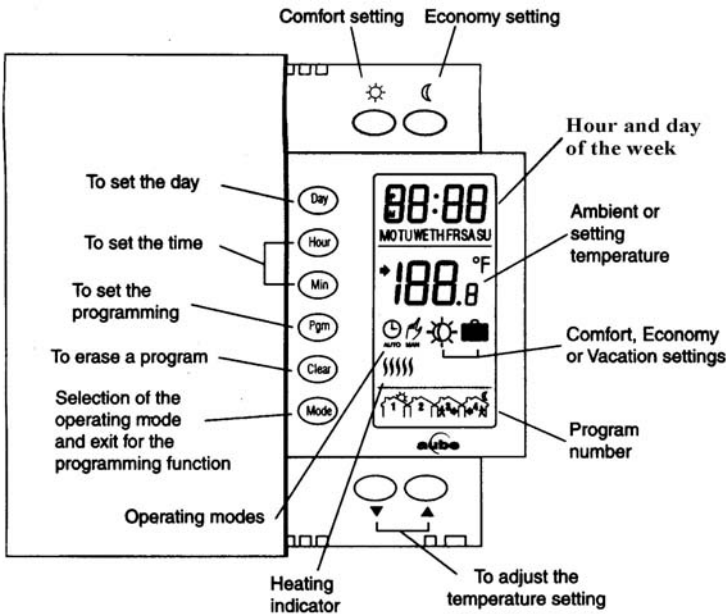

## CONNECTING WIRES AND MOUNTING THERMOSTAT

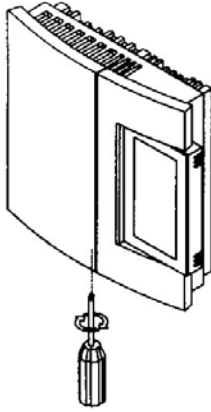

Remove the screw holding the base and the front part of the thermostat.

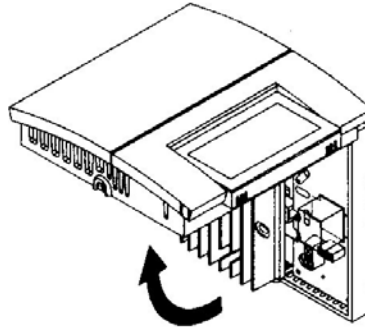

Lift the front part of the thermostat to separate it from the base.

Make the appropriate connections. Please note that the thermostat wires are not polarized, therefore the connections can be made on either terminal.

### 2 wire installation

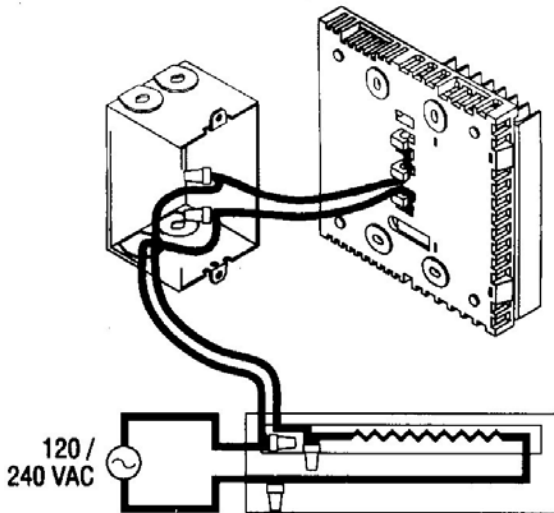

### 4 wire installation

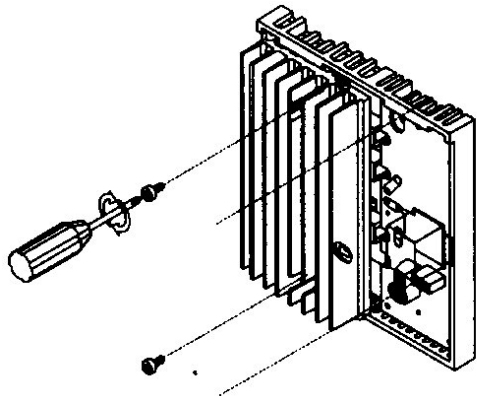
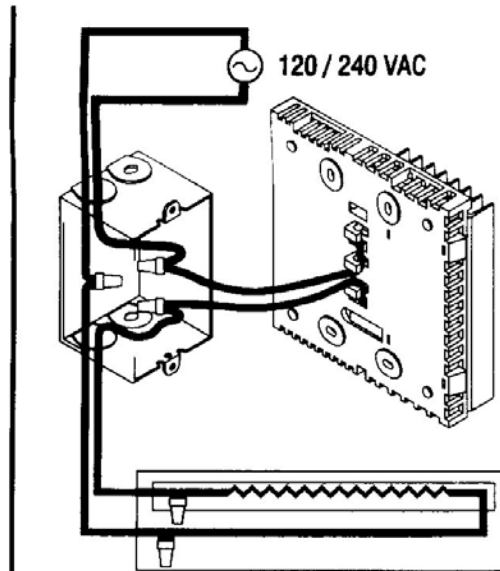

Align and afix the base to the electrical box.

Set the 4 switches located at the back of the thermostat to your preferences.

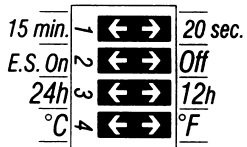

- 1: Cycles of 15 min. (fan) or 20 sec.
- 2: Early Start
- 3: Time display in 12 or 24 hours
- 4: Temperature display in °C or °F

NOTE 1: This thermostat has been factory set to proportionally control electric baseboards radiant systems and convectors. Since proportional control uses a fast commutation rate, it is not compatible with fan equipped systems (see characteristics). Also, this control mode could occasionally create light flickering, especially in rural area.

**By switching to the 15 minute cycle mode, the thermostat will be compatible with fan equipped systems.**

NOTE 2. The thermostat is providing a built-in function enabling it to calculate the optimum time to start the heating system to achieve the desired temperature setting at the programmed time. To enable this function, set the switch E.S. to "ON" at the back of the thermostat.

Replace the front part of the thermostat on the base and secure them in place with the screw.

NOTE: All cables and connections must conform to the local electrical code.

WARNING: Special CO/ALR solderless connectors must be used when connecting with aluminium conductors.

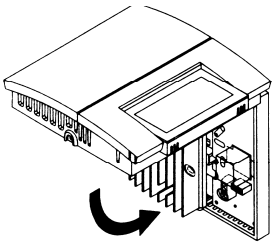

## Power-up

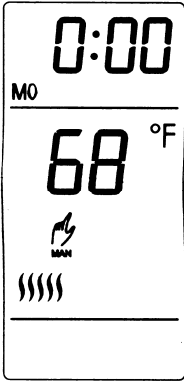

When power is applied for the first time, the display must show the time 0:00, the ambient temperature and the Manual mode icon ( ). Other information might show up on the display if installation is defective or does not comply with the instructions.

### 500 watts or less Installation

During the 30 minute period following the installation or a long power failure (more than 2 hours), the light intensity of the display decreases when a button is pressed while the thermostat is in the heat mode. This problem will disappear when the accumulator for the memory backup will be charged.

## OPERATING MODES

The TH106 has two (2) operating modes:

MANual ( )

This mode allows you to maintain a constant ambient temperature.

1 - To activate this mode, press on Mode button to display the icon.

2- Set the desired temperature using the buttons or select the preprogrammed settings.  
(To select the setting, press on and simultaneously.)

AUTOMATIC ( )

This mode executes your own programming.

To activate this mode, press on Mode button to display the icon. The or icon indicates which temperature setting is used.

## TELEPHONE CONTROLLER

The TH106 incorporates a telephone controller interface which allows you to switch from the normal operating mode to the Vacation setting ( ), and vice versa, using the telephone keypad (stationary or portable). You can, for example, heat your country house from your office on Friday, or your house from the airport or from your car on your way back from vacation. When the telephone controller sends a signal, the icon appears on the screen.

### Connection to the CT240

The TH106 is designed to connect directly to the CT240 telephone controller. This combination allows the activation and deactivation of the Vacation mode from the CT240 or the telephone.

Connect the CT240's terminals A and C to the TH106's terminals X and C respectively. You must respect the polarity. The signal given by the CT240 is a low voltage signal and must not circulate in the electrical box. The wire must run on the exterior side of the electrical box to join the thermostat.

Use a 18 to 22 gauge flexible wire and pass it behind the thermostat through the slot located in front of the connector.

For details on operating the telephone controller, refer to the CT240's Instruction Manual.

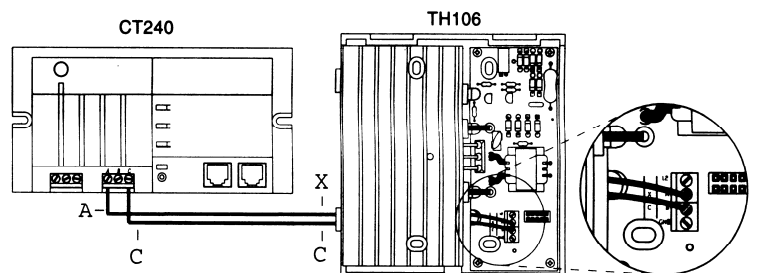







# PROGRAMMING













## Programming the time and day

- 1 - Set the time using the Hour and Min buttons.
- 2 - Set the day using the Day button

## Programming the Comfort, Economy and Vacation settings









The Comfort  , Economy  and Vacation  settings respectively represent the temperatures that you wish to have during the day  , at night or while you are away at work  , or while you are away for an extended period  .

### To program your settings

- a) To program the Comfort temperature, select the desired degree using the   buttons and press the  button until the  icon is displayed (app. 3 seconds).
- b) To program the Economy temperature, select the desired degree using the   buttons and press the  button until the  icon is displayed (app. 3 seconds).
- c) To program the Vacation temperature, select the desired degree using the   buttons and press on the  and  buttons simultaneously until the  icon is displayed (app. 3 seconds).
- d) Press the Mode button to exit this function and return to the normal operating mode.

## Schedule programming

The TSSHC-3DP-2/3/4/7 allows 4 setting changes for each day of the week. There are no pre-set programs. The programs are tailored to perfectly adapt to your life style. The principle is very simple. For each day, enter the time at which you awake (P1), the time you leave for work (P2), the time you arrive back home (P3) and the time you go to bed (P4).

Program	Mode	Time
		Comfort Wake-up time
		Economy Leaving time
		Comfort Return time
		Economy Bed time

For savings to be obtained, you must lower the temperature for a period of 2 to 3 times the delay required to bring the temperature back to your comfort level.

Example: If your system takes one hour to go from your saving temperature level to your comfort temperature level, it is useless to lower the temperature for a period less than 2 to 3 hours.

### a) To Program your schedule:

- 1- Press on PGM button to access the programming mode.
- 2- Press on Day button to select the day to be programmed. You can select all days of the week by pressing on Day button for 3 seconds.
- 3- Press on PGM button to select program 1, 2, 3 or 4.
- 4- Press on Hour and Min buttons to program the time.
- 5- When you have completed your programming, press on Mode button to exit this function.

### b) To Erase a Program

Select the program using PGM and Day buttons, and press on Clear button. The time field displays --:-- when the program is inactive.

- c) Example 1:** Comfort period from 7:00 AM to 10:30 PM  
 Economy period from 10:30 PM to 7:00 AM  
 Identical schedule for all days of the week.

Schedule/Day	MON.	TUES.	WED.	THU.	FRI.	SAT.	SUN.
PROG. 1 ☀	7:00 AM	7:00AM	7:00AM	7:00AM	7:00AM	7:00AM	7:00AM
PROG. 2 ☾	---	---	---	---	---	---	---
PROG. 3 ☀	---	---	---	---	---	---	---
PROG. 4 ☾	10:30 PM	10:30 PM	10:30 PM	10:30 PM	10:30 PM	10:30 PM	10:30 PM

- 1 - Press on PGM button to access the programming mode.
- 2 - Press on Day button 3 seconds to select every day of the week.
- 3 - Press on Hour button to enter 7:00 AM, Prog. 1 (☀)
- 4 - Press 3 times on PGM button to select Prog. 4 (☾) and press on Hour and Min buttons to enter 10:30 PM.
- 5 - Press on Mode button to exit this function.

**d) Example 2:** Comfort period Monday to Friday from 6:15 AM to 8:15 AM and from 5:00 PM to 10:00 PM. Saturday and Sunday from 7:30 AM to 11:00 PM

Schedule/Day	MON.	TUES.	WED.	THU.	FRI.	SAT.	SUN.
PROG 1 ☀	6:15 AM	6:15 PM	6:15 AM	6:15 AM	6:15 AM	7:30 AM	7:30 AM
PROG. 2 ☾	8:15 AM	8:15 PM	8:15 AM	8:15 AM	8:15 AM	---	---
PROG. 3 ☀	5:00 PM	5:00 PM	5:00 PM	5:00 PM	5:00 PM	...	---
PROG. 4 ☾	10:00 PM	10:00 PM	10:00 PM	10:00 PM	10:00 PM	11:00 PM	11:00PM

NOTE: It is faster to program the same schedule for every day and then modify the exception days.

- 1 - Press on PGM button to access the programming mode.
- 2 - Press on Day button 3 seconds to select every day of the week.
- 3 - Press on Hour and Min buttons to enter 6:15 AM Prog. 1, (☀)
- 4 - Press on PGM button to select Prog. 2 (☾) and Hour and Min buttons to enter 8:15 AM.
- 5 - Repeat step 4 to enter Prog. 3 (5:00 PM) and Prog. 4 (10:00 PM).

NOTE: When making modifications, make sure you are in the right program.

**To modify the Saturday and Sunday schedules:**

- 6 - Press on Day button until SA or SU is displayed.
- 7 - Press on PGM button to select Prog. 1 ☀ and Hour and Min buttons to enter 7:30 AM.
- 8 - Press on PGM button to select Prog. 2 ☾ and then Clear button to erase it.
- 9 - Press on PGM button to select Prog. 3 ☀ and then Clear button to erase it.
- 10 - Press on PGM button to select Prog. 4 ☾ and then Hour and Min buttons to enter 11:00 PM.
- 11 - Press on Mode button to exit this function.

**TEMPORARY OR PERMANENT TEMPERATURE BYPASS**

This operation allows you to temporarily modify the temperature while you are in the Automatic mode.

Simply press on ☀ or ☾ button to select the desired temperature, or the ☀ or ☾ button to select the Comfort or Econo setting you have programmed. This temperature will be maintained until the beginning of the next program.

You can also switch to the Vacation setting for a prolonged absence by pressing on ▲ and ▼ buttons at the same time. The display will show icon. In that case, the temperature bypass is permanent. To return to the normal operating mode, press on Mode button.

If you wish to return immediately to the programmed settings, press on Mode button twice.

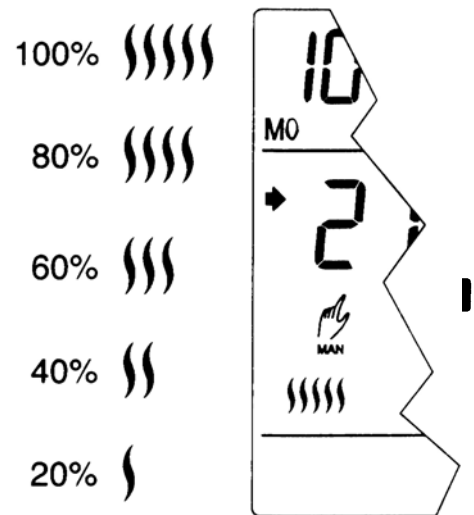

## MEMORY BACKUP



In the event of a power failure, an internal circuit will maintain the programming. Only the time will have to be set if the power failure is more than two hours. The thermostat will return to the same operating mode as set before the power failure.

## CHARACTERISTICS

This thermostat works differently than the conventional electromechanic one. The letter can have a differential of temperature up to 4 °C (7.2 °F) while this electronic thermostat has one of only 0.2 °C (0.36 °F). This slight oscillation eliminates the discomfort often found with conventional electromechanic thermostats.

The proportional controller determines the amount of power required by the electric heating system to maintain the exact ambient temperature of the temperature setting.

To see this process, the display shows, in real time, the percentage of power applied to the electric heating system.

Model:	TSSHC-3DP-2/3/4/7
Supply:	120/240 VAC, 50/60 Hz
Load:	16.7 A max. (resistive only) 1.0 A min.
Power:	4000 W @ 240 VAC, 2000 W @ 120 VAC
Minimal load:	240 W @ 240 VAC, 120 W @ 120 VAC
Approval:	CUILus
Display range:	0 to 60 °C (32 to 140 °F)
Setting range:	5 to 30 °C (40 to 85 °F)
Storage:	-20 to 50 °C (-4 to 120 °F)
 Default setting:	20 °C (68 °F)
 Default setting:	18 °C (64 °F)
 Default setting:	10 °C (50 °F)

## WARRANTY

ONE (1) YEAR LIMITED WARRANTY

## PROBLEMS AND SOLUTIONS

PROBLEMS	CAUSES	SOLUTIONS
- No display	- Circuit breaker is open - Power failure - Open linear limit control	- Check 120 / 240 VAC presence at the thermostat
-The LCD disappears but reappears after a 2 to 3 minute period	The thermal protection unit on the baseboard heater opens after a power failure or a malfunction	- Ensure that the baseboard heater is not obstructed by Furniture or curtains. Also verify that the linear limit control of the thermal protection unit is not touching the heating element
The thermostat is hot	In normal use at full capacity (4000 W), the housing temperature of the thermostat can reach 35 to 40 °C	
The thermostat is losing the time but not the programming	Power failure more than 2 hours	
Room temperature shown is wrong	A draft is near the thermostat	Eliminate the draft
Heating system always on	Bad installation	Check installation
The thermostat displays heating but heating system is not turned on	Bad installation	Check installation
Programs do not change as you want	Incorrect programming hours - Wrong programming mode selected	Check actual time in AM & PM as well as program Times (AM is not displayed) Make sure operating mode is set to AUTO
Erratic or dim display		For a 500 W or less installation, the display could appear dim after the first power-up or a long power failure when the thermostat is in heat mode. See first power-up section